

NOBILI



TB TB-S

Trince specializzate per gli spazi verdi

Specialized mulchers for green spaces

Trituradoras especializadas para los espacios verdes



TB TB-S

Per la trinciatura di spazi verdi, argini e bordi stradali

I Triturator Nobili TB e TB-S sono attrezzature di tipo semi-portato applicabili ai tre punti del sollevatore e spostabili con braccio a parallelogramma. Studiate per i professionisti della manutenzione del paesaggio, le trince TB e TB-S sono ideali per la trinciatura di superfici inerbite e per la manutenzione di bordi stradali, argini, siepi, prati e giardini. Specializzate e robuste, le trince TB e TB-S sono costruite in acciaio ad alta resistenza e appoggiano su rullo e su slitte che ne regolano l'altezza di lavoro. I Triturator sono costruiti in conformità alle Normative Europee.

For the shredding of green areas, embankments and roadsides

The Nobili TB and TB-S mulchers are tractor-mounted machines to be fitted to the three-point linkage of the tractor lift, side-shiftable through a parallelogram arm. Conceived for landscape maintenance professionals, TB and TB-S mulchers are suitable for shredding grassy areas and for maintenance of roadsides, embankments, hedges, lawns and gardens. Specialized and sturdy, TB and TB-S mulchers are built with high resistance steel and are supported by roller and skids adjusting the working height. The mulchers are constructed in compliance with the European regulations.

Para la trituración de áreas verdes, taludes y márgenes de carreteras

Las Trituradoras Nobili TB y TB-S son equipos de tipo suspendido en tres puntos para enganchar al levantador del tractor, desplazables lateralmente a través de un brazo de paralelogramo. Concebidas para los profesionales del mantenimiento del paisaje, las trituradoras TB y TB-S son ideal para la trituración de zonas verdes y para el mantenimiento de márgenes de carreteras, taludes, setos, césped y jardines. Especializadas y robustas, las trituradoras TB y TB-S están construidas con acero de alta resistencia y son apoyados por rodillo y patines para el control de altura de trabajo. Las trituradoras son fabricadas en conformidad con las Directivas Europeas.



TB SERIE 10

TB serie 10

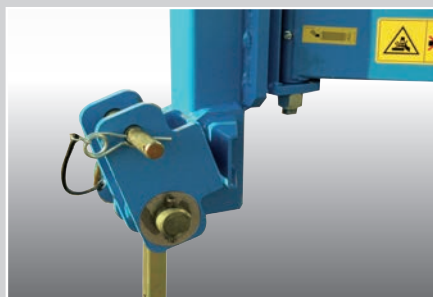

TB serie 10 – Biella di sicurezza per gli urti accidentali in lavoro.

TB series 10 – Safety articulation against accidental shocks while working.

TB serie 10 - Articulación de seguridad contra golpes accidentales durante el trabajo.

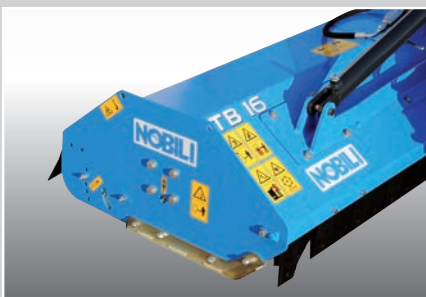

TB serie 10 – Telaio in acciaio ad alta resistenza e supporti rotore interni.

TB series 10 – Chassis made of high resistance steel and inner rotor supports.

TB serie 10 – Chasis de acero de alta resistencia y soportes rotor internos.



TB serie 10 – Mazza brevettata su boccola temprata e perno trattato.

TB series 10 – Patented hammer on hardened bushing and treated axle.

TB serie 10 – Martillo patentado sobre casquillo templado y eje tratado.

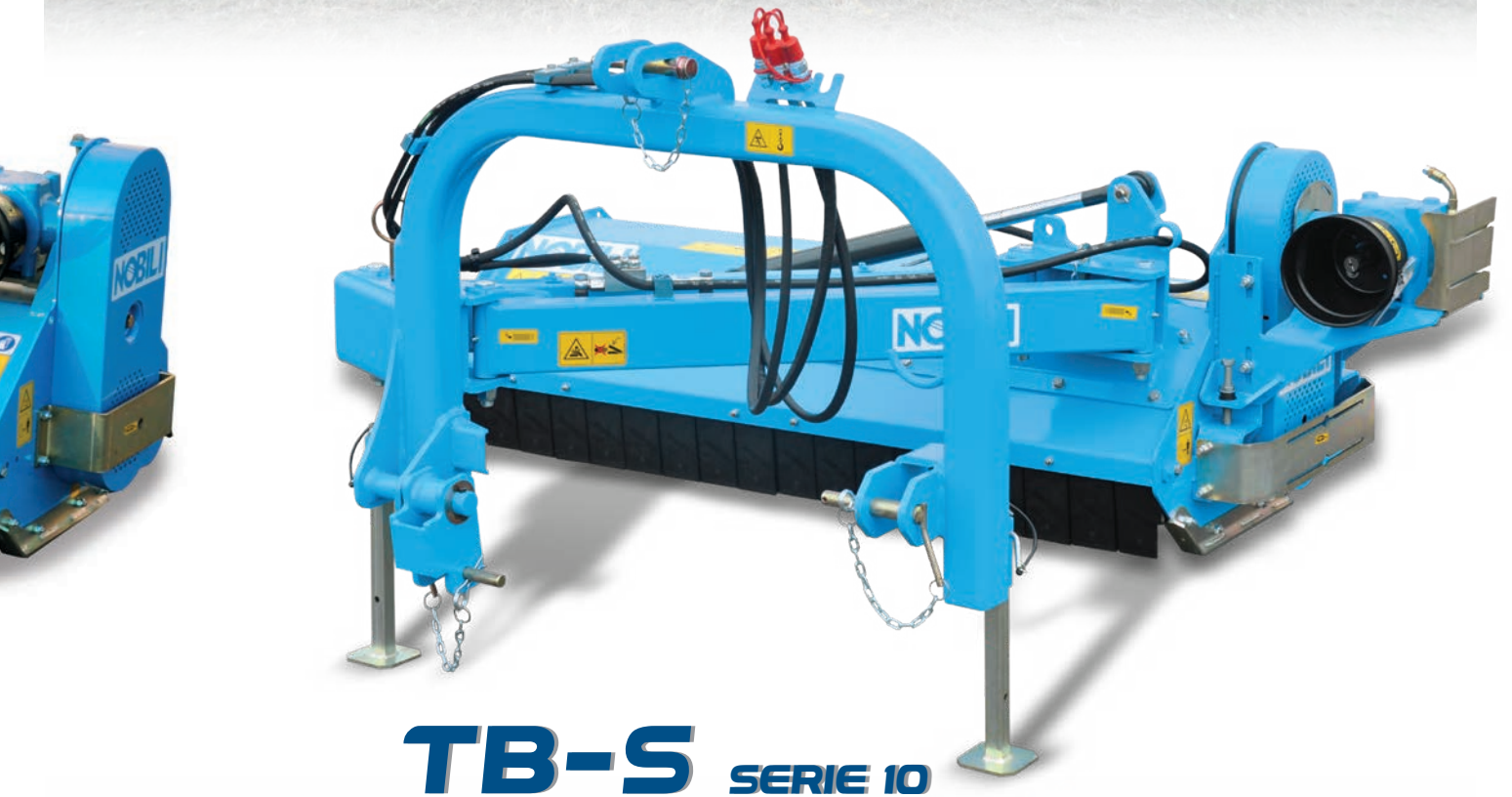

TB-S SERIE 10





TB serie 100 – Testata di taglio flottante con cilindro a semplice effetto per seguire gli avvallamenti del terreno.

TB series 100 – Floating cutting head with single acting cylinder for ground adaptation.

TB serie 100 – Cajón de trituración flotante con cilindro de simple efecto para el seguimiento del terreno.



TB SERIE 100

TB serie 100



TB serie 100 – Bracci a parallelogramma di 1500 mm per lavorare sempre al di fuori dalla carreggiata del trattore.

TB series 100 – Parallelogram arms – 1500 mm long – for working always outside the tractor wheel track.

TB serie 100 – Brazos de paralelogramo – 1500 mm de largo – para trabajar siempre fuera de la pista de la rueda del tractor.



TB serie 100 – Braccio sfilabile con sistema di sicurezza contro gli urti accidentali in lavoro.

TB series 100 – Telescopic arm with safety device against accidental shock in work.

TB serie 100 – Brazo telescópico con dispositivo de seguridad contra choques accidentales en trabajo.

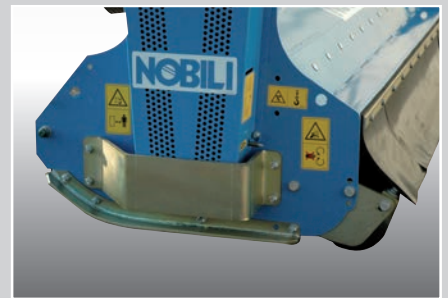

TB serie 100 – Protezione per gli urti laterali spostabile in due posizioni (bassa e alta).

TB series 100 – Protection against side shocks movable in two positions (low and high).



TB serie 100 – Protección contra los golpes laterales móvil en dos posiciones (bajo y alto).



TB serie 10: Adatte alla trinciatura di argini con pendenze di 45°
 TB series 10: Suitable for shredding of embankments with 45° slopes
 TB serie 10: Ideal para la trituración de taludes con pendientes de 45°

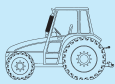

TB/TB-S serie 10: Adatte alla trinciatura di siepi a 90°
 TB/TB-S serie 10: Conceived for the shredding of hedges at 90°
 TB/TB-S serie 10: Concebidas para la trituración de setos a 90°

Caratteristiche tecniche Technical specifications Características técnicas		SERIE 10			
		TB 14	TB 16	TB 18	
Attacco Linkage Enganche		1° e 2° categoria category 1 - 2 categoria 1 - 2			
	Larghezza di lavoro Working width Anchura de trabajo	mm	1400	1600	1800
	Larghezza massima della testata Overall width of the cutting head Anchura máxima del cajón de trituración	mm	1600	1800	2000
Numero giri presa di forza PTO transmission speed Frecuencia de rotación t.d.f.		rpm	540	540	540
	Potenza Trattore compresa tra Tractor power requirement ranging from Potencia tractor incluida entre	CV	30 - 80	40 - 80	50 - 80
		kW	22 - 59	29 - 59	37 - 59
Ruota libera Free wheel Rueda libre		Sul gruppo rinvio - Integrated in gearbox - Integrada en la caja			
Trasmissione del rotore Rotor drive Transmisión rotor		N. 2	Cinghie SPBX SPBX belts Correas SPBX	N. 3	Cinghie SPBX SPBX belts Correas SPBX
Diametro del rotore Rotor tube diameter Diámetro rotor		mm	374	374	374
Velocità di rotazione del rotore Rotor speed Velocidad de rotación rotor		rpm	2220	2220	2220
Velocità lineare dei coltelli Blades linear speed Velocidad lineal de cuchillas		m/s	44	44	44
	Numero di coltelli Number of knives Número de cuchillas	06	20	24	28
		01-08	-	-	-
		09L	-	-	-
Regolazione dell'altezza Height control Control de altura		mm	Rullo, ruote - Roller, whels - Rodillo, ruedas		
Peso Weight Peso		Kg	460	480	520



TB serie 100: Trinciatura nella carreggiata del trattore
 TB series 100 : Mulching in the tractor roadway
 TB serie 100: Trituración en la carretera del tractor



TB serie 100: Adatte alla trinciatura di siepi a 90°
 TB series 100: Conceived for the shredding of hedges at 90°
 TB serie 100: Concebidas para la trituración de setos a 90°

CARATTERISTICHE - SPECIFICATIONS - CHARACTERISTICS

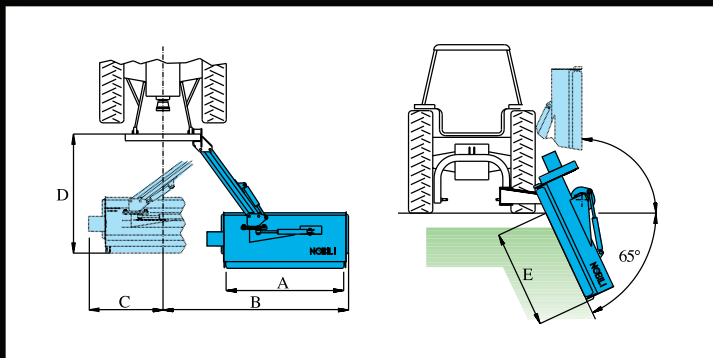

	TBE SERIE IO					TBE SERIE 100	
	TB 14	TB 16	TB 18	TB-S 14	TB-S 16	TB 181	TB 211
A	1400	1600	1800	1400	1600	1750	2050
B	2160	2360	2560	2490	2690	2741	3026
C	672	672	672	485	485	975	975
D	1820	1820	1820	1820	1820	2115	2115
E	1250	1450	1650	1250	1450	1550	1850
α	45°	45°	45°	45°	45°	65°	65°

SERIE IO		SERIE 100	
TB-S 14	TB-S 16	TB 181	TB 211
1° e 2° categoria category 1 - 2 categoria 1 - 2	1° e 2° categoria category 1 - 2 categoria 1 - 2	2° categoria category 2 categoria 2	2° categoria category 2 categoria 2
1400	1600	1765	2050
1600	1800	2041	2326
540	540	540	540
30 - 80	40 - 80	65 - 110	70 - 110
22 - 59	29 - 59	48 - 81	51 - 81
Sul gruppo rinvio - Integrated in gearbox - Integrada en la caja		Sul gruppo rinvio - Integrated in gearbox - Integrada en la caja	
N. 2 Cinghie SPBX SPBX belts Correas SPBX	N. 3 Cinghie SPBX SPBX belts Correas SPBX	N. 3 Cinghie SPBX SPBX belts Correas SPBX	N. 3 Cinghie SPBX SPBX belts Correas SPBX
374	374	400	400
2220	2220	2220	2220
44	44	47	47
20	24	24	28
-	-	48	56
-	-	24	28
Rullo, ruote - Roller, whels - Rodillo, ruedas		Rullo, ruote - Roller, whels - Rodillo, ruedas	
505	525	760	780

SERIE IO		SERIE 100			
	06		01		06
			08		09L

Concessionario / dealer / distribuidor



40062 MOLINELLA (Bologna) - Italy - Tel. +39 051 881444
Fax +39.051.88.27.03 - www.nobili.com - info@nobili.com

Per rispetto dell'ambiente, questo documento è stampato su carta senza cloro. - In respect for the environment, this document is printed on chlorine-free paper. Las características de los modelos se ofrecen a modo de indicativo. Le caractéristiques des modèles sont données à titre indicatif. - Specifications subject to change without notice. S.p.A. se reserva el derecho de modificarlas en cualquier momento, sin preaviso alguno.